

SPMV SERIES

High Capacity AC Motor/Pump Units 430-1730 gph

Designed for high capacity applications where 430-1730 gph are required. Quiet running, gear type pumps are available in four sizes and incorporate hardened integral shafts, journals and gears, special anti friction bearings, Buna N seals, and cast iron gear plates. Standard motors ranging from 1/2 hp to 7.5 hp (373 W to 5.6 kw) are 1725 rpm NEMA "C" face, 115 volt single-phase or 230 volt three-phase, 60 cycle type with TEFC enclosures through 2 hp (1490 W) and OPDP enclosures over 2 hp (1490 W).

Webster AC motor/pump high capacity fuel oil supply units are designed to be used with fuel oils including JP4 whose viscosities do not exceed 6,000 S.U.S. and with a suction less than 10" of mercury or an inlet pressure not to exceed 35 psi continuously (capable of intermittent duty at 10,000 S.U.S., 20" of mercury and 50 psi inlet). The unit is designed to operate in -20°F to +200°F conditions. The motor is precision aligned and coupled to the pump with a machined adapter and flexible couplings.

SPM/SPMV DUPLEX

Pump/Motor Units

Available in flow rates from 430 GPH through 1730 GPH. Systems can be designed for single phase 115/208/230V, 60 or 50CY, or three phase 208/230/460V, 60 or 50CY, applications. The SPM duplex models consist of two pump and motor assemblies with a pre-piped common discharge manifold. One pump operates continuously, with the second providing backup services if the main pump fails. Either automatic (SPM-DA models) or manual (SPM-DM models) controls are available. The duplex automatic series are designed specifically for buildings where a constant supply of oil must be assured...hospitals, apartment buildings, schools and other commercial or industrial buildings. The duplex pump set has a second pump for standby or auxiliary service. Furnished with automatic or manual standby controls, the duplex automatic is equipped with a pressure sensing device which detects loss of pressure of primary pump. If standby pump is brought into service, an alarm sounds which indicates malfunction in primary pump. The electric control circuit on the duplex automatic pump set is equipped with a lead-lag switch to permit manual alternation of pump to provide even pump wear. The manually operated duplex pump sets offer the same protection as the automatic except the standby pump must be turned on manually which requires that maintenance personnel always be available. Available with either SPM or SPMV pump/motor units.

SPECIFICATIONS

SPMV SERIES

AC High Capacity Fuel Oil Supply Units

Capacity:

430 to 1730 gph with fluid viscosity to 10,000 SSU.

Pressure:

Inlet pressure not to exceed 35 psi.

Outlet pressure up to 500 psi.

Fluid Temperature Limits:

-20° F to +200° F.

Motors:

Standard: 60 cycle, 1750 rpm, NEMA 56C frame.

1/2 through 7 1/2 hp available.

To be specified when ordering: Single-phase 115/230 VAC, or three-phase 230/460 VAC. ODP or TEFC.

Porting:

1" NPT (086K-194K)

1 1/2 X 1 1/4 NPT (237K-388K)

Mounting:

Integral mounting foot.

Maximum Inlet Pressure:

Continuous operation: 10" Hg or pressure not to exceed 35 psi.

Use of external filter recommended.

In applying these supply units, the pressures indicated are at the pump outlet. You must also consider line losses.

All pumps relying on atmospheric pressure to push the fuel oil into them are subject to cavitation. As fuel viscosity (thickness) increases, the tendency for cavitation becomes greater. Therefore, it is best to mount the pump at the base of the tank and to use the largest diameter, shortest length, and straightest inlet possible. A large diameter inlet pipe or hose necked down at the pump is preferable to a longer length of smaller diameter pipe because the fuel tends to adhere to the inside of the pipe.

When initially starting a unit, it is desirable and sometimes necessary to have a vent valve or plug on the pressure side of the pump to facilitate its priming.

SPMV PUMP CODE ANALYSIS SELECTION TABLES

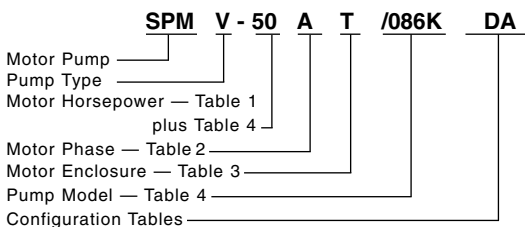

Table 1. Motor Horsepower (1725 rpm Standard)

No.	Description
50	.50 hp
75	.75 hp
100	1.0 hp
150	1.5 hp
200	2.0 hp
300	3.0 hp
500	5.0 hp
750	7.5 hp

Table 2. Motor Phase

Code	Description
A	Single-phase, 60 cycle, 115/230 VAC
B	Three-phase, 60 cycle, 230/460 VAC
X	Consult factory for other types

Table 3. Motor Enclosure

Code	Description
T	TEFC std. thru 2 hp
O	OPDP std. over 2 hp
P	Explosion Proof

Table 4. Pump Model

Maximum gph Nominal	Pump Model	Under Pressure, Read Horsepower Required at 1750 rpm			
		25 psi	100 psi	200 psi	300 psi
439	086K	.50	.75	1.00	1.50
900	194K	1.00	1.75	2.50	3.00
1114	237K	1.00	2.00	3.00	4.00
1730	388K	2.00	3.50	4.50	6.00

HP ratings shown are for No. 2 fuel oil. Consult factory for hp ratings for heavier weight oils. For lower flow rates consult Bulletin 131-49161. For higher pressures and/or flow rates, consult factory.

SPMV Duplex Ordering Code

When ordering SPMV Duplex models add suffix:

“DM,” for manual control models, or “DA,” for automatic control models.

Example: SPMV-50AT/086K-DA

Code	Duplex Units
DM	Duplex with manual controls
DA	Duplex with automatic controls

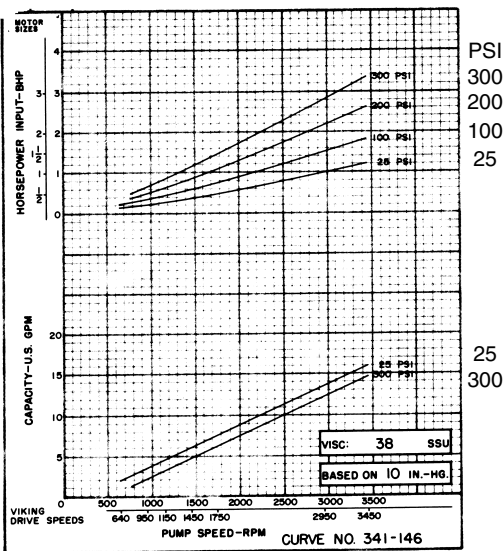

086K

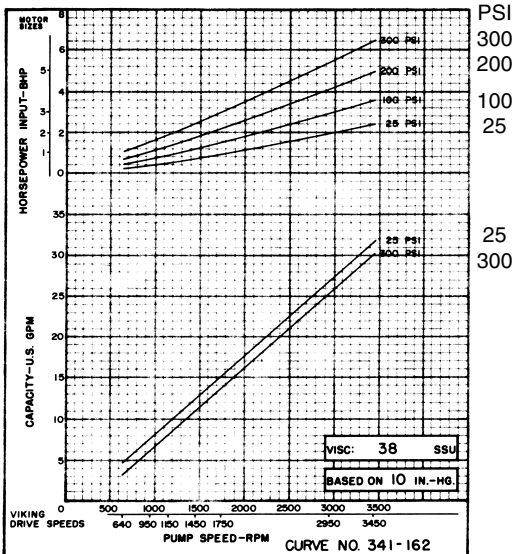

194K

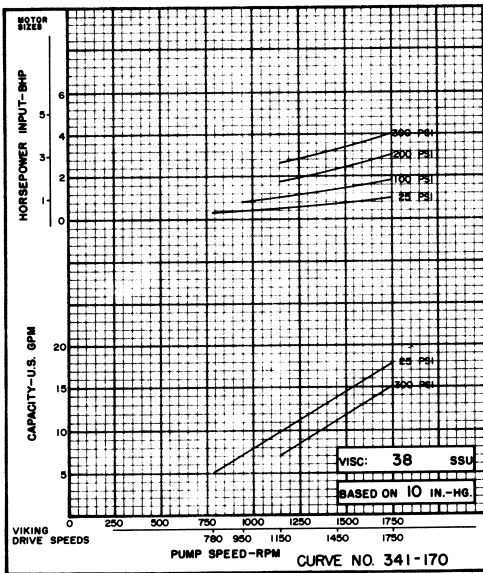

237K

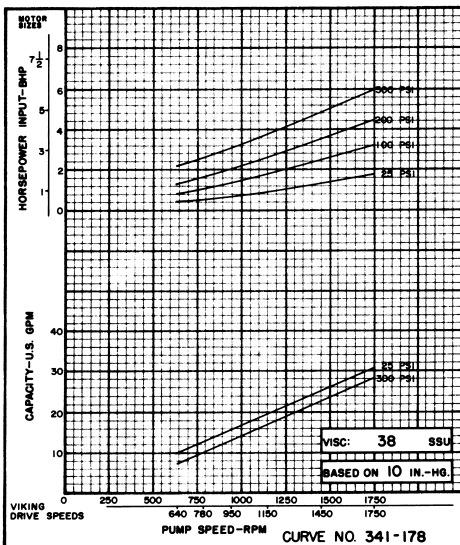

388K

SPMV Series Single and Duplex Supply Units

DIMENSIONS

<i>Motor</i>			<i>A</i>	<i>B</i>	<i>C</i>	<i>D</i>
<i>HP</i>	<i>NEMA Frame Size</i>	<i>Type (Standard)</i>				
.50	56C	TEFC	6.30	9.00	8.25	9.20
.75	56C	TEFC	6.30	9.00	8.25	9.20
1.00	56C	TEFC	6.30	9.00	8.25	10.20
1.50	56C	TEFC	6.30	9.00	8.25	11.20
2.00	56C	TEFC	6.30	9.00	8.25	11.20
3.00	182TC	OPDP	7.30	9.63	11.05	11.00
5.00	184TC	OPDP	7.30	9.63	11.05	12.40
7.50	213TC	OPDP	8.00	11.63	13.00	13.90

<i>Pump Model</i>	<i>E</i>	<i>F</i>	
		<i>Minimum</i>	<i>Maximum</i>
086K	4.90	19.05 (.50HP)	20.85 (3.00HP)
194K	5.65	19.80 (.75HP)	23.10 (5.00HP)
237K	8.80	22.95 (.75HP)	27.85 (7.50HP)
388K	9.80	23.95 (.75HP)	28.65 (7.50HP)

SPMV SINGLE SUPPLY UNIT

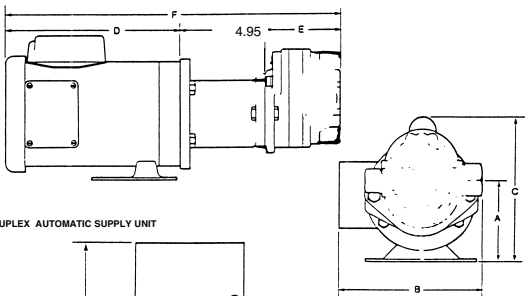

SPMV DUPLEX AUTOMATIC SUPPLY UNIT

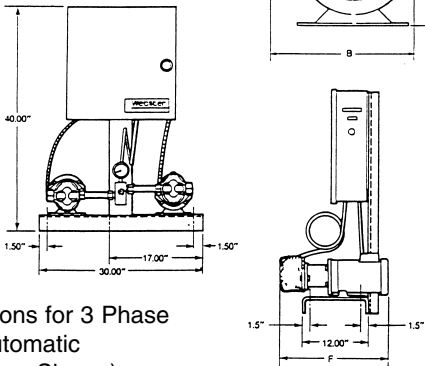

Dimensions for 3 Phase Duplex Automatic Assembly as Shown)